



THE STRONG HEART OF THE VALVES

MADE IN ITALY



## IL NOSTRO IMPEGNO AL CUORE DELLE VALVOLE

Da oltre 50 anni BBD realizza seggi di tenuta e componenti per il montaggio di valvole industriali. Grazie alla considerevole esperienza acquisita nel corso del tempo, la società è in grado di offrire grande professionalità e flessibilità organizzativa, unite alla base da una elevata qualità delle attività produttive.

In BBD è sempre attiva la linea imprenditoriale che ha fatto dell'attenzione e dell'ascolto dei collaboratori un punto di forza, un vero e proprio valore aggiunto nella gestione delle risorse umane e nel miglioramento continuo dell'organizzazione.

L'attività della nostra società è da sempre orientata ad un'attenta partnership; grazie a un ufficio tecnico composto da persone con pluriennale esperienza, siamo in grado di sviluppare progetti in collaborazione con i clienti che ci consentono di raggiungere lo stato dell'arte nella realizzazione di componenti per valvole industriali.

La costante ricerca di nuove soluzioni di analisi della tenuta consente a BBD di inserirsi sempre più in una logica di partecipazione nello sviluppo tecnico dei progetti e quindi di saper meglio interagire nelle fasi di lavorazione.

## OUR MISSION AT THE HEART OF THE VALVES

For more than 50 years, BBD manufactures sealing seats and components for the assembly of industrial valves. Thanks to the considerable experience gained over time, the company is able to offer great professionalism and organizational flexibility, combined with the high quality of productive activities.

BBD is always an entrepreneurial line that has made the attendance and listening to staff a point of strength, a real added value in human resource management and continuous improvement of the organization.

The activity of our company has always been oriented towards a close partnership; thanks to a technical department composed of people with many years of experience, we are able to develop projects in collaboration with our customers.

The constant search for new sealing analysis solutions allows BBD to become increasingly involved in technical development of projects and therefore to know how to interact in the processing phases.

## ANALISI, ACCIAI, TRATTAMENTI E TEST

### Analisi di tenuta

- Analisi tenuta seggio-sfera
- Tenuta soffice O-ring / Delta ring
- Tenuta MTM

### Acciai

- A105, A350 LF2/LF3, A694 F60, AISI 4140
- A182 F6A/F6NM
- A182 F316/L/LN, A182 F51/F53/F55/F60 17-4 PH, XM19
- INCONEL 625/718/725/825, MONEL 400/K500, HASTELLOY C276
- Altri materiali: titanio, stellite, bronzo

### Materiali termoplastici

- PTFE VERGINE, PTFE c/CG 25%, PTFE c/VETRO, CABFLUOR M25, PTFE DYNEON TFM
- DEVLON V API, NYLON 6 MOS2, ERTALON 6XAU, NYLON PA12G (LAURAMID) SINVEX SMX, VESPEL Dupont
- PEEK VERGINE, PEEK c/PTFE 20%, PEEK c/PTFE/CARBONE/GRAFITE
- P.C.T.F.E. (KEL-F)
- VESPEL Dupont

### Elastomeri

- HNBR, HNBR AED
- FKM/VITON A AED, FKM/VITON B AED, FKM/VITON GLT AED, FKM/VITON GF AED, TFE AFLAS

### Grafite

- Grafite FIRE-SAFE

### Trattamenti superficiali, riporti, claddatura

- Nichelatura - E.N.P.
- Rivestimento di Carburi di Silicio - NiSiC
- Rivestimenti TCC - CCC - Stellite
- Claddatura

### Test materiali: prove interne

- PMI - Durezza
- UT - PT (2° Level)
- Blu di Prussia - Bubble Test

## ANALYSIS, STEELS, TREATMENTS AND TESTS

### Sealing analysis

- Ball-Seat sealing analysis
- Soft seal with O-ring / Delta ring
- MTM seal

### Steels

- A105, A350 LF2/LF3, A694 F60, AISI 4140
- A182 F6A/F6NM
- A182 F316/L/LN, A182 F51/F53/F55/F60 17-4 PH, XM19
- INCONEL 625/718/725/825, MONEL 400/K500, HASTELLOY C276
- Other materials: titanium, stellite, bronze

### Thermoplastic materials

- PTFE VIRGIN, PTFE c/CG 25%, PTFE c/GLASS, CABFLUOR M25, PTFE DYNEON TFM
- DEVLON V API, NYLON 6 MOS2, ERTALON 6XAU, NYLON PA12G (LAURAMID) SINVEX SMX, VESPEL Dupont
- PEEK VIRGIN, PEEK c/PTFE 20%, PEEK c/PTFE/CARBON/GRAPHITE
- P.C.T.F.E. (KEL-F)
- VESPEL Dupont

### Elastomers

- HNBR, HNBR AED
- FKM/VITON A AED, FKM/VITON B AED, FKM/VITON GLT AED, FKM/VITON GF AED, TFE AFLAS

### Graphite

- Graphite FIRE-SAFE

### Surface treatments, coatings, cladding

- Nickel plating - E.N.P.
- Ni.Silicon carbide plating
- TCC - CCC - Stellite coatings
- Cladding

### Material tests: inside tests

- PMI - Hardness
- UT - PT (2° Level)
- Prussian Blue Test - Bubble Test

## LA NOSTRA TECNOLOGIA AL CUORE DELLE VALVOLE

### Componenti per valvole a sfera Side Entry

- Seggio con inserto rigido
- Seggio con Delta ring
- Seggio con O-ring
- Seggio metallico
- Seggio floating
- Sfera
- Stelo
- Kit per valvole Side Entry

### Componenti per valvole a sfera Top Entry

- Seggio Top Entry con inserto rigido
- Seggio Top Entry con Delta ring
- Seggio Top Entry con O-ring
- Seggio Top Entry metallico
- Anello porta molle
- Distanziale a settori
- Kit per valvole Top Entry

### Componenti per valvole a saracinesca

- Seggio saracinesca con O-ring
- Seggio saracinesca con doppio inserto rigido
- Seggio saracinesca metallico
- Lama
- Stelo
- Kit seggi-lama-stelo

### Componenti per seggi

- Inserto rigido termoplastico
- O-ring
- Delta ring
- Anelli anti estrusione
- Guarnizioni energizzate
- Grafite FIRE-SAFE
- Molle

## OUR TECHNOLOGY AT THE HEART OF THE VALVES

### Components for Side Entry ball valves

- Seat with hard insert
- Seat with Delta ring
- Seat with O-ring
- Metal to Metal seat
- Floating seat
- Ball
- Stem
- Kit for Side Entry valves

### Components for Top Entry ball valves

- Top Entry seat with hard insert
- Top Entry seat with Delta ring
- Top Entry seat with O-ring
- Metal to Metal Top Entry seat
- Springs holder ring
- Sector spacer
- Kit for Top Entry valves

### Components for gate valves

- Gate seat with O-ring
- Gate seat with double hard insert
- Metal to Metal seat for gate valve
- Gate
- Stem
- Seats-gate-stem kit

### Components for seats

- Thermoplastic hard insert
- O-ring
- Delta ring
- Anti-extrusion rings
- Energized gaskets
- Graphite FIRE-SAFE
- Springs

## KIT PER VALVOLE SIDE ENTRY / KIT FOR SIDE ENTRY VALVES

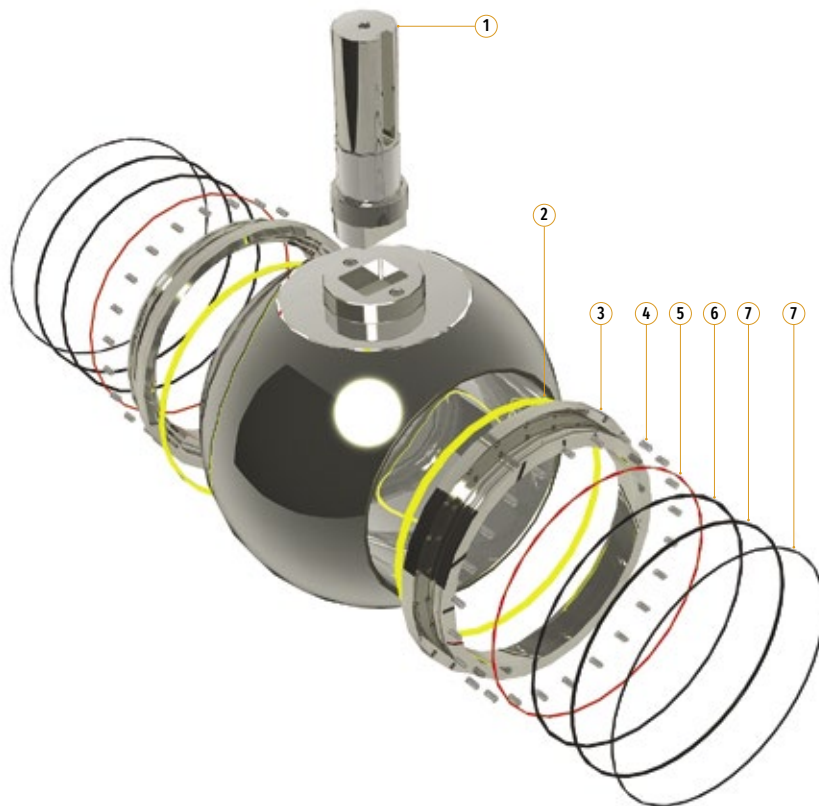

1 > Stem

2 > Thermoplastic hard insert

3 > Seat

4 > Springs

5 > Graphite FIRE-SAFE

6 > Anti-extrusion ring

7 > O-ring



## KIT LAMA - SEGGI - STELO / GATE - SEATS - STEM KIT

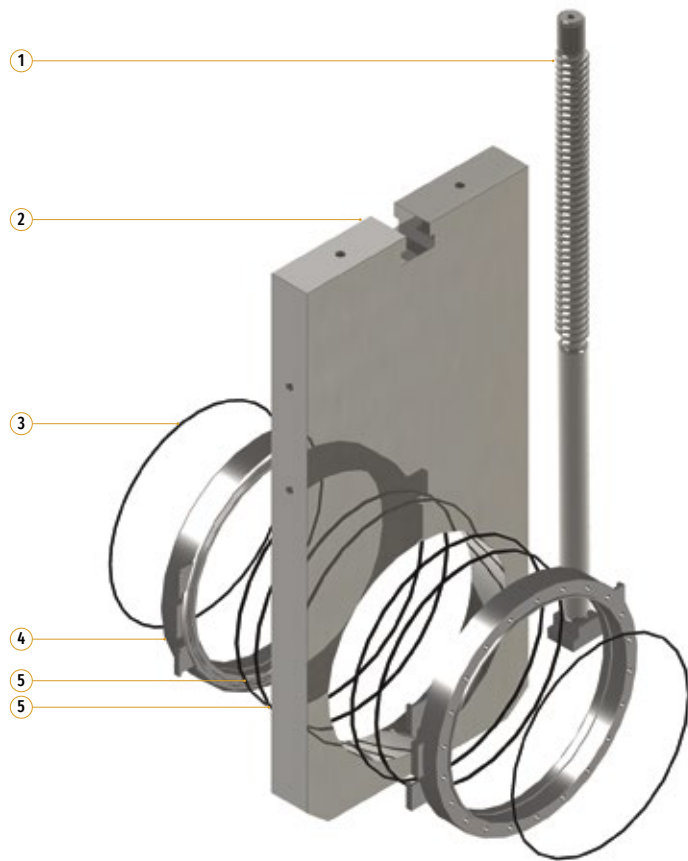

1 > Stem

2 > Gate

3 > O-ring

4 > Gate seat with double hard insert

5 > Thermoplastic hard insert

# VALVOLE A SFERA SIDE ENTRY / SIDE ENTRY BALL VALVES

Componenti / Components

## SEGGIO SIDE ENTRY CON INSERTO RIGIDO

### SIDE ENTRY SEAT WITH HARD INSERT



> SPE con inserto termoplastico  
> SPE with hard insert

- 1 > Thermoplastic inserted ring
- 2 > Graphite ring
- 3 > Anti-extrusion ring
- 4 > O-ring
- 5 > O-ring or grease guard

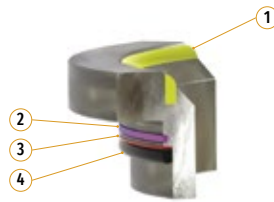

> DPE con inserto rigido  
> DPE with hard insert

- 1 > Thermoplastic inserted ring
- 2 > Graphite ring
- 3 > Anti-extrusion ring
- 4 > O-ring



DPE con inserto rigido, Lip seal  
DPE with hard insert, Lip seal

- 1 > Thermoplastic inserted ring
- 2 > Graphite ring
- 3 > Lip seal
- 4 > Retainer ring

## SEGGIO SIDE ENTRY CON O-RING

### SIDE ENTRY SEAT WITH O-RING

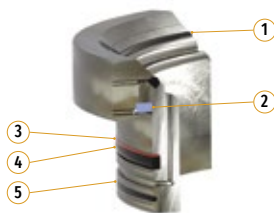

> SPE con O-ring  
> SPE with O-ring

- 1 > O-ring
- 2 > Elastic ring
- 3 > Anti-extrusion ring
- 4 > O-ring
- 5 > O-ring or grease guard

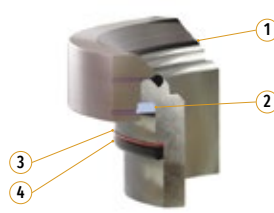

> DPE con O-ring  
> DPE with O-ring

- 1 > O-ring
- 2 > Elastic ring
- 3 > Anti-extrusion ring
- 4 > O-ring



# VALVOLE A SFERA SIDE ENTRY / SIDE ENTRY BALL VALVES

Componenti / Components

## SEGGIO SIDE ENTRY CON DELTA RING

### SIDE ENTRY SEAT WITH DELTA RING



> SPE con Delta ring, anello elastico metallico  
> SPE with Delta ring, elastic metal ring

- 1 > Elastic metal ring
- 2 > Elastometric Delta ring
- 3 > Graphite ring
- 4 > Anti-extrusion ring
- 5 > O-ring
- 6 > O-ring or grease guard

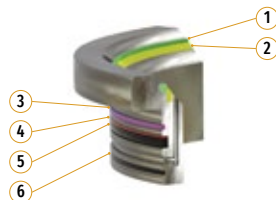

> SPE con Delta ring, inserto termoplastico  
> SPE with Delta ring, thermoplastic insert

- 1 > Elastometric ring
- 2 > Thermoplastic inserted ring
- 3 > Graphite ring
- 4 > Anti-extrusion ring
- 5 > O-ring
- 6 > O-ring or grease guard



> SPE con Delta ring, anello elastico metallico, inserto termoplastico  
> SPE with Delta ring, elastic metal ring, thermoplastic insert

- 1 > Elastic metal ring
- 2 > Elastometric Delta ring
- 3 > Thermoplastic inserted ring
- 4 > Graphite ring
- 5 > Anti-extrusion ring
- 6 > O-ring
- 7 > O-ring or grease guard

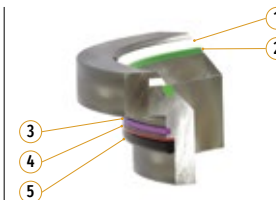

> DPE con Delta ring, anello elastico metallico  
> DPE with Delta ring, elastic metal ring

- 1 > Elastic metal ring
- 2 > Elastometric Delta ring
- 3 > Graphite ring
- 4 > Anti-extrusion ring
- 5 > O-ring

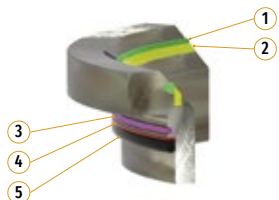

> DPE con Delta ring e inserto termoplastico  
> DPE with Delta ring and thermoplastic insert

- 1 > Elastometric Delta ring
- 2 > Thermoplastic inserted ring
- 3 > Graphite ring
- 4 > Anti-extrusion ring
- 5 > O-ring

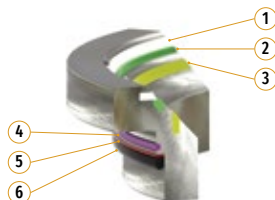

DPE con Delta ring, anello elastico metallico, inserto termoplastico  
DPE with Delta ring, elastic metal ring, thermoplastic insert

- 1 > Elastic metal ring
- 2 > Elastometric Delta ring
- 3 > Thermoplastic inserted ring
- 4 > Graphite ring
- 5 > Anti-extrusion ring
- 6 > O-ring

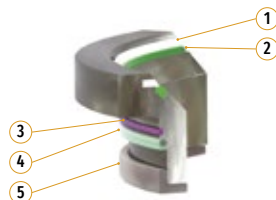

> DPE con Delta ring, anello elastico metallico, Lip seal  
> DPE with Delta ring, elastic metal ring, Lip seal

- 1 > Elastic metal ring
- 2 > Elastometric Delta ring
- 3 > Graphite ring
- 4 > Lip seal
- 5 > Retainer ring

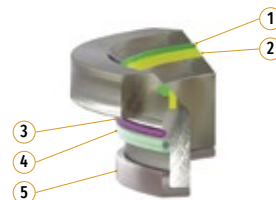

DPE con Delta ring, inserto termoplastico, Lip seal  
DPE with Delta ring, thermoplastic insert, Lip seal

- 1 > Elastometric Delta ring
- 2 > Elastometric inserted ring
- 3 > Graphite ring
- 4 > Lip seal
- 5 > Retainer ring

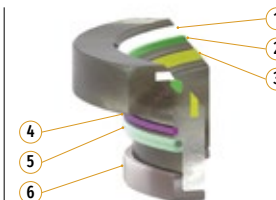

DPE con Delta ring, anello elastico metallico, inserto termoplastico  
DPE with Delta ring, elastic metal ring, thermoplastic insert, Lip seal

- 1 > Elastic metal ring
- 2 > Elastometric Delta ring
- 3 > Thermoplastic inserted ring
- 4 > Graphite ring
- 5 > Lip seal
- 6 > Retainer ring

# VALVOLE A SFERA SIDE ENTRY / SIDE ENTRY BALL VALVES

Componenti / Components

## SEGGIO SIDE ENTRY METALLICO

### METAL TO METAL SIDE ENTRY SEAT

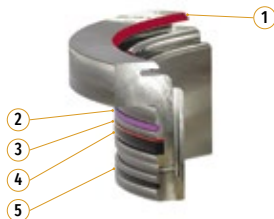

- > SPE metal to metal
- > Metal to metal SPE

- 1 > Tungsten carbide coating
- 2 > Graphite ring
- 3 > Anti-extrusion ring
- 4 > O-ring
- 5 > O-ring or grease guard

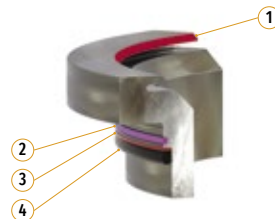

- > DPE metal to metal
- > Metal to metal DPE

- 1 > Tungsten carbide coating
- 2 > Graphite ring
- 3 > Anti-extrusion ring
- 4 > O-ring

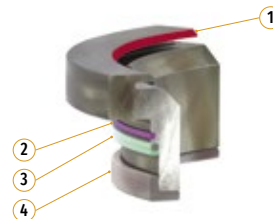

- > DPE metal to metal, Lip seal
- > Metal to metal DPE, Lip seal

- 1 > Tungsten carbide coating
- 2 > Graphite ring
- 3 > Lip seal
- 4 > Retainer ring

## SEGGIO FLOATING FLOATING SEAT



## STELO / STEM



## SFERA / BALL



# VALVOLE A SFERA TOP ENTRY / TOP ENTRY BALL VALVES

Componenti / Components

## SEGGIO TOP ENTRY CON INSERTO RIGIDO

### TOP ENTRY SEAT WITH HARD INSERT

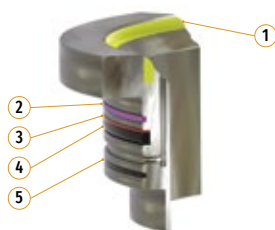

> SPE con inserto termoplastico  
> SPE with thermoplastic insert

- 1 > Thermoplastic inserted ring
- 2 > Graphite ring
- 3 > Anti-extrusion ring
- 4 > O-ring
- 5 > O-ring or grease guard

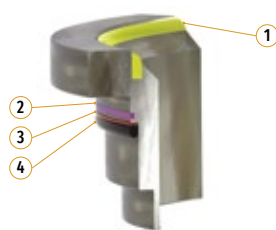

> DPE con inserto termoplastico  
> DPE with thermoplastic insert

- 1 > Thermoplastic inserted ring
- 2 > Graphite ring
- 3 > Anti-extrusion ring
- 4 > O-ring

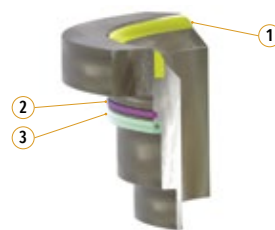

> DPE con inserto termoplastico, Lip Seal  
> DPE with thermoplastic insert, Lip seal

- 1 > Thermoplastic inserted ring
- 2 > Graphite ring
- 3 > Lip seal

## SEGGIO TOP ENTRY CON O-RING

### TOP ENTRY SEAT WITH O-RING

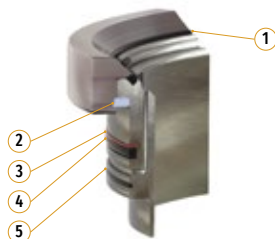

> SPE con O-ring  
> SPE with O-ring

- 1 > O-ring
- 2 > Elastic ring
- 3 > Anti-extrusion ring
- 4 > O-ring
- 5 > O-ring or grease guard

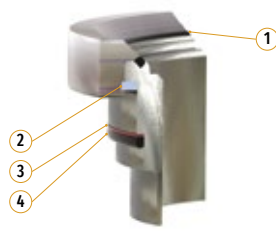

> DPE con O-ring  
> DPE with O-ring

- 1 > O-ring
- 2 > Elastic ring
- 3 > Anti-extrusion ring
- 4 > O-ring

# VALVOLE A SFERA TOP ENTRY / TOP ENTRY BALL VALVES

Componenti / Components

## SEGGIO TOP ENTRY CON DELTA RING

### TOP ENTRY SEAT WITH DELTA RING

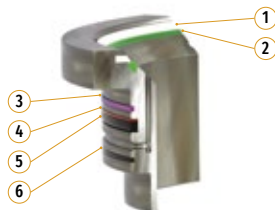

> SPE con Delta ring, anello elastico metallico  
> SPE with Delta ring and elastic metal ring

- 1 > Elastic metal ring
- 2 > Elastometric Delta ring
- 3 > Graphite ring
- 4 > Anti-extrusion ring
- 5 > O-ring
- 6 > O-ring or grease guard

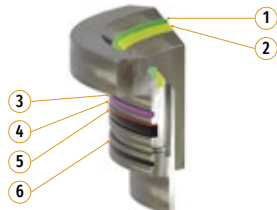

> SPE con Delta ring, inserto termoplastico  
> SPE with Delta ring, thermoplastic insert

- 1 > Elastic Delta ring
- 2 > Thermoplastic inserted ring
- 3 > Graphite ring
- 4 > Anti-extrusion ring
- 5 > O-ring
- 6 > O-ring or grease guard

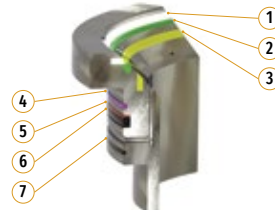

> SPE con Delta ring, anello elastico metallico, inserto termoplastico  
> SPE with Delta ring, elastic metal ring, thermoplastic insert

- 1 > Elastic metal ring
- 2 > Elastometric Delta ring
- 3 > Thermoplastic inserted ring
- 4 > Graphite ring
- 5 > Anti-extrusion ring
- 6 > O-ring
- 7 > O-ring or grease guard

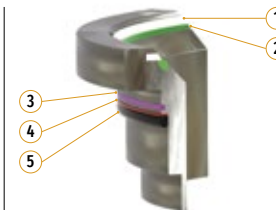

> DPE con Delta ring, anello elastico metallico  
> DPE with Delta ring and elastic metal ring

- 1 > Elastic metal ring
- 2 > Elastometric Delta ring
- 3 > Graphite ring
- 4 > Anti-extrusion ring
- 5 > O-ring

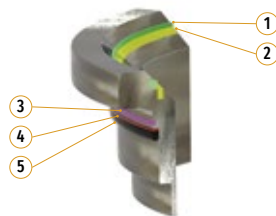

> DPE con Delta ring, inserto termoplastico  
> DPE with Delta ring, thermoplastic insert

- 1 > Elastometric Delta ring
- 2 > Thermoplastic inserted ring
- 3 > Graphite ring
- 4 > Anti-extrusion ring
- 5 > O-ring

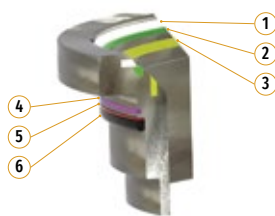

> DPE con Delta ring, anello elastico metallico, inserto termoplastico  
> DPE with Delta ring, elastic metal ring, thermoplastic insert

- 1 > Elastic metal ring
- 2 > Elastometric Delta ring
- 3 > Thermoplastic inserted ring
- 4 > Graphite ring
- 5 > Anti-extrusion ring
- 6 > O-ring

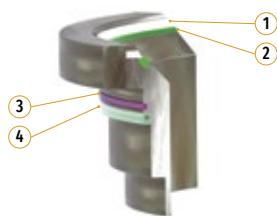

> DPE con Delta ring, anello elastico metallico, Lip seal  
> DPE with Delta ring, elastic metal ring, Lip seal

- 1 > Elastic metal ring
- 2 > Elastometric Delta ring
- 3 > Graphite ring
- 4 > Lip seal

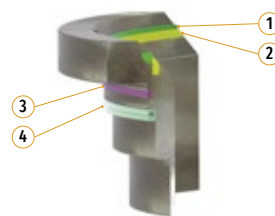

> DPE con Delta ring, inserto termoplastico, Lip seal  
> DPE, with Delta ring, thermoplastic insert, Lip seal

- 1 > Elastometric Delta ring
- 2 > Elastometric inserted ring
- 3 > Graphite ring
- 4 > Lip seal

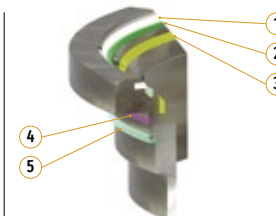

> DPE, con Delta ring, anello elastico metallico, inserto termoplastico, Lip seal  
> DPE, with Delta ring, elastic metal ring, thermoplastic insert, Lip seal

- 1 > Elastic metal ring
- 2 > Elastometric Delta ring
- 3 > Thermoplastic inserted ring
- 4 > Graphite ring
- 5 > Lip seal

## SEGGIO TOP ENTRY METALLICO

### METAL TO METAL TOP ENTRY SEAT

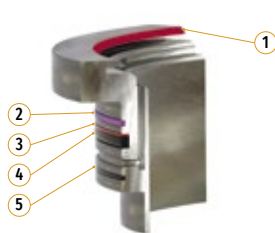

- > SPE metal to metal
- > Metal to metal SPE

- 1 > Tungsten carbide coating
- 2 > Graphite ring
- 3 > Anti-extrusion ring
- 4 > O-ring
- 5 > O-ring or grease guard

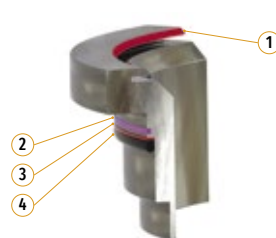

- > DPE metal to metal
- > Metal to metal DPE

- 1 > Tungsten carbide coating
- 2 > Graphite ring
- 3 > Anti-extrusion ring
- 4 > O-ring

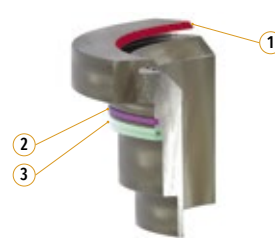

- > DPE metal to metal, Lip seal
- > Metal to metal DPE, Lip seal

- 1 > Tungsten carbide coating
- 2 > Graphite ring
- 3 > Lip seal

## ANELLO PORTA MOLLE SPRINGS HOLDER RING

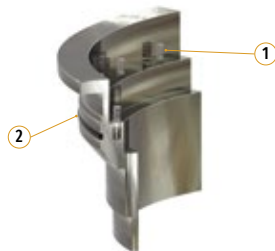

- > Anello porta molle alto
- > High springs holder ring

- 1 > Springs
- 2 > O-ring



- > Anello porta molle basso
- > Low springs holder ring

- 1 > Springs

## DISTANZIALE A SETTORI SECTOR SPACER



## SEGGIO SARACINESCA CON O-RING

GATE SEAT WITH O-RING



## SEGGIO SARACINESCA CON DOPPIO INSERTO RIGIDO

GATE SEAT WITH DOUBLE  
HARD INSERT



## SEGGIO SARACINESCA METALLICO

METAL TO METAL GATE SEAT



## STELO STEM

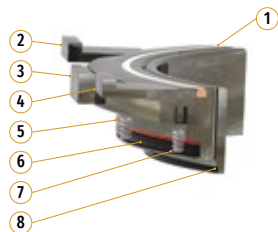

Con O-ring  
With O-ring

- 1 > O-ring
- 2 > Right pilot plate
- 3 > Gate lower stop
- 4 > Left pilot plate
- 5 > Anti-extrusion ring
- 6 > O-ring
- 7 > Springs
- 8 > O-ring or grease guard

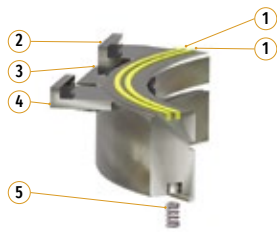

> Con doppio inserto termoplastico  
> With double thermoplastic insert

- 1 > Thermoplastic inserted ring
- 2 > Right pilot plate
- 3 > Gate lower stop
- 4 > Left pilot plate
- 5 > Springs

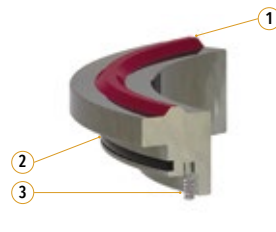

> Metal to metal  
> Metal to metal

- 1 > Tungsten carbide coating
- 2 > O-ring
- 3 > Springs

## LAMA GATE



# COMPONENTI PER SEGGI / COMPONENTS FOR SEATS

## INSERTO RIGIDO TERMOPLASTICO THERMOPLASTIC HARD INSERT



## O-RING O-RING



## DELTA RING DELTA RING

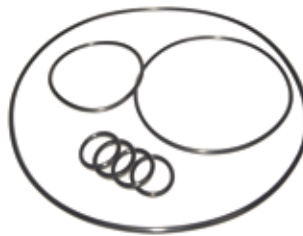

## ANELLI ANTI-ESTRUSIONE ANTI-EXTRUSION RINGS



## GRAFITE FIRE-SAFE GRAPHITE FIRE-SAFE



## GUARNIZIONI ENERGIZZATE ENERGIZED GASKETS



## MOLLE SPRINGS



**UNI EN ISO 14001-2015**  
Sistema di gestione ambientale  
Environmental Management System

**BS OHSAS 18001-2007**  
Sistema di gestione salute e sicurezza sul lavoro  
Occupational Health and Safety Management System

**UNI EN ISO 9001-2015**  
Sistema di gestione qualità  
Quality Management System



**BBD Srl** • Valve components

Via Enrico Mattei, 6 • 27020 Marcignago (PV) • Italy

T / P: +39.0382.92.17.08 • F: +39.0382.92.17.87

[info@bbdsrl.it](mailto:info@bbdsrl.it) • [www.bbdsrl.it](http://www.bbdsrl.it)

